

RRX Rigid PVC Wiring Ducts

RRE® is an established brand in the middle east that produces quality LV accessories for electrical control panels. RRE's RRX series Rigid PVC slotted cable trunking (otherwise known as slotted wiring ducts) is a part of cable management solutions and products produced by the company. Our PVC wiring ducts channel cables within electrical control panels with ease, enhancing the system's safety.

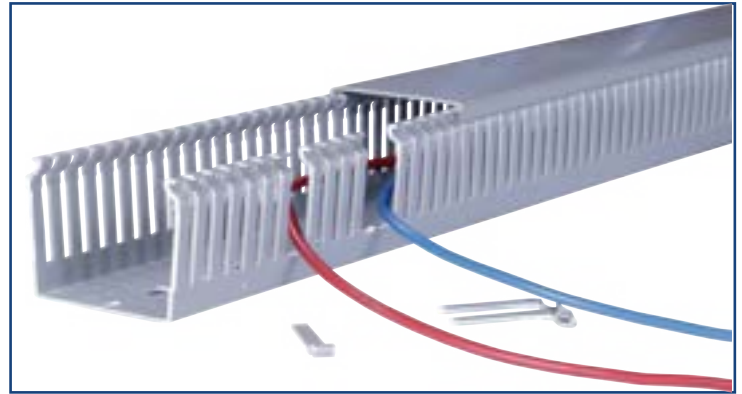

RRX series rigid PVC wiring ducts

Benefits and Features

- Manufactured from specially compounded high-impact rigid PVC (Polyvinyl Chloride)
- Pre-notch snap-off points enable fingers to be removed effortlessly.
- Self-extinguishing and warp-proof.
- Highly tensile and good compressive strength, hence the wiring ducts do not peel, chip or crack.
- Unique locking design provides easy mounting and removal of duct covers, and prevents popping of wires.
- Elongated slots and punched holes on the base as per DIN EN 50085-2-3 standards.
- Secure duct covers that are well-fixed even in vertical positions.

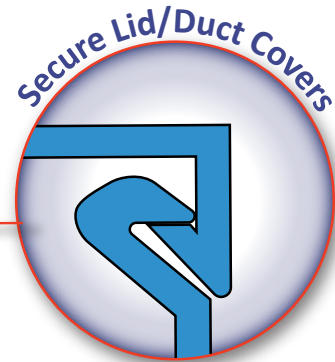

Product Properties

Properties	
Mechanical	
Colour	Grey (RAL7032)
Length	2 m
Tensile Strength	390 kg/cm ²
Electrical	
Dielectric Strength	36 kV/mm
Specific resistance	6.1 x 10 ¹⁴ Ω-m
Thermal	
Flammability	UL 94 V0

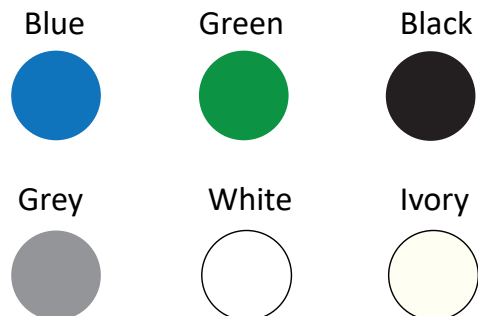

*Other colours such as Blue, Green, Black, Ivory and white are available on request for bulk orders.

*Halogen free and RoHs compliant materials are available on request.

Technical Data - Slot/Hole Pattern

Product-No.	Size (WxH)	A	B	C	D	E
RRX2525	25 x 25	-	-	12.5	6.5 x 14.5	4.5 x 8
RRX2540	25 x 40	-	-	12.5	6.5 x 14.5	4.5 x 8
RRX2560	25 x 60	-	-	12.5	6.5 x 14.5	4.5 x 8
RRX2580	25x80	-	-	12.5	6.5 x 14.5	4.5 x 8
RRX25100	25x100	-	-	12.5	6.5 x 14.5	4.5 x 8
RRX4040	40x40	-	-	20	6.5 x 14.5	4.5 x 8
RRX4060	40x60	-	-	20	6.5 x 14.5	4.5 x 8
RRX4080	40x80	-	-	20	6.5 x 14.5	4.5 x 8
RRX40100	40x100	-	-	20	6.5 x 14.5	4.5 x 8
RRX6040	60x40	-	-	30	6.5 x 14.5	4.5 x 8
RRX6060	60x60	-	-	30	6.5 x 14.5	4.5 x 8
RRX6080	60x80	-	-	30	6.5 x 14.5	4.5 x 8
RRX60100	60x100	-	-	30	6.5 x 14.5	4.5 x 8
RRX8060	80x60	50	15	-	6.5 x 14.5	4.5 x 8
RRX8080	80x80	50	15	-	6.5 x 14.5	4.5 x 8
RRX80100	80x100	50	15	-	6.5 x 14.5	4.5 x 8
RRX10080	100x80	50	25	-	6.5 x 14.5	4.5 x 8
RRX100100	100x100	50	25	-	6.5 x 14.5	4.5 x 8

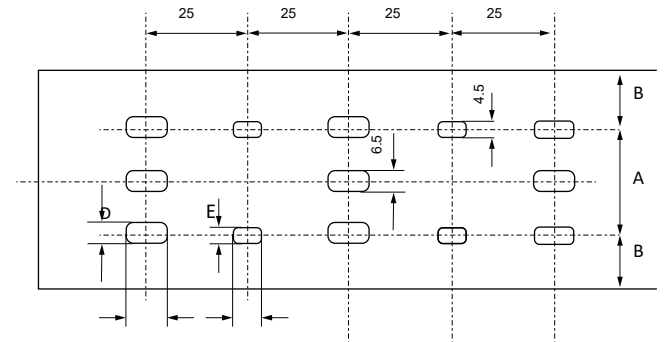

Sizes : 80x60, 80x80, 80x100, 100x100,

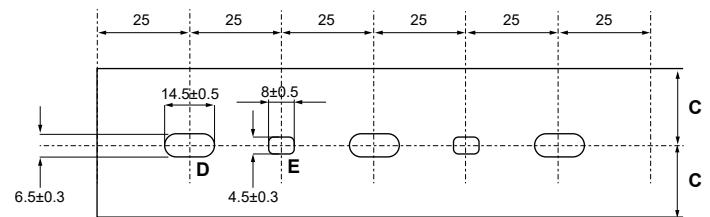

Sizes: 25x25, 25x40, 25x60, 25x80, 25x100, 40x40, 40x60, 40x80, 40x100, 60x60, 60x80, 60x100

*All dimensions in mm. Subject to technical changes.

Technical Data - Dimension

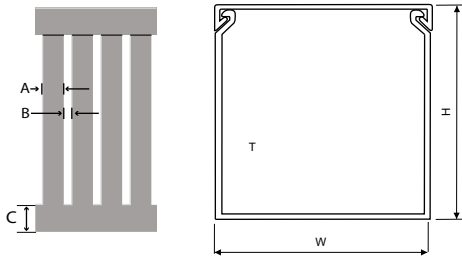

RRE Extrusions- RRX wiring ducts

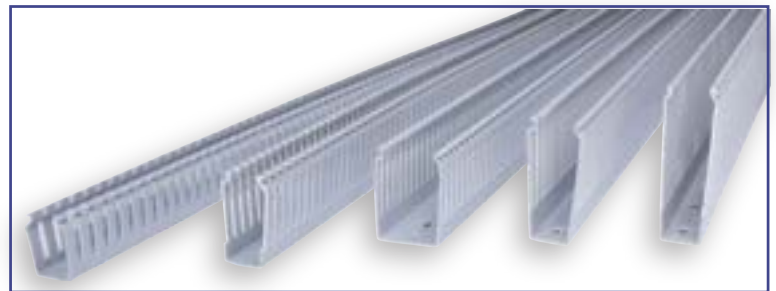

Product-No.	Width (W)	Height (H)	Thickness (T)	A	B	C	Packing Content (units/carton)
RRX2525	25	25	1.2	6	4	10	50
RRX2540	25	40	1.5	7.5	5	8	40
RRX2560	25	60	1.5	6	4	12	28
RRX2580	25	80	1.5	6	4	18	28
RRX25100	25	100	1.6	6	4	18	12
RRX4040	40	40	1.5	7.5	5	8	24
RRX4060	40	60	1.5	6	4	12	28
RRX4080	40	80	1.6	6	4	15	20
RRX40100	40	100	1.6	6	4	18	16
RRX6040	60	40	1.6	6	4	8	28
RRX6060	60	60	1.6	6	4	12	24
RRX6080	60	80	1.8	6	4	15	18
RRX60100	60	100	1.8/1.9	6	4	18	12
RRX8060	80	60	1.8	6	4	15	12
RRX8080	80	80	1.8	6	4	18	8
RRX80100	80	100	2.0	6	4	12	18
RRX10080	100	80	2.0	6	4	18	18
RRX100100	100	100	2.0	6	4	18	8

*All dimensions in mm. Subject to technical changes.

Cable Housing Capacity

Product-No.	Size (WxH)		Maximum No. of Cables accomodated		
	mm	Inch	1.5 mm ² (AWG# 16)	2.5 mm ² (AWG# 14)	4.0mm ² (AWG# 12)
			OD 3.18mm	OD 3.53mm	OD 4.01mm
RRX2525	25 x 25	0.98 x 0.98	19	15	12
RRX2540	25x40	0.98 x 1.57	48	35	24
RRX2560	25x60	0.98 x 2.36	72	55	40
RRX2580	25x80	0.98 x 3.15	96	75	54
RRX25100	25x100	0.98 x 3.94	138	95	70
RRX4040	40x40	1.57 x 1.57	80	72	48
RRX4060	40x60	1.57 x 2.36	130	108	70
RRX4080	40x80	1.57 x 3.15	180	153	91
RRX40100	40x100	1.57 x 3.94	230	198	126
RRX6040	60x40	2.36 x 1.57	130	108	70
RRX6060	60x60	2.36 x 2.36	195	168	110
RRX6080	60x80	2.36 x 3.15	270	224	154
RRX60100	60x100	2.36 x 3.94	345	234	198
RRX8060	80x60	3.15 x 2.36	270	224	154
RRX8080	80x80	3.15 x 3.15	450	378	255
RRX80100	80x100	3.15 x 2.36	270	224	154
RRX10080	100x80	3.94 x 3.15	270	224	154
RRX100100	100x100	3.94 x 3.94	600	462	342

*OD stands for outer diameter of the cable



An ISO 9001:2015 certified manufacturer

About Us

RRE Cable Trunking systems are manufactured under ISO 9001:2015 QMS standards in UAE, by RR Extrusions FZ -LLC with a technical experience of producing quality **PVC products**. Our PVC cable trunking products are made from high quality PVC resin, and the design (Sizes and perforations) affirms to DIN EN 50085-2-3 (VDE 0604-2-3). RRE provides quality PVC products with finesse which will help companies build secure control panel systems and incorporate efficient cable management within their switchgear and automation ecosystem.

Contact Information

<https://royalswitchgeardubai.com/>

info@royalswitchgeardubai.com

+971 50 430 9767 / +971 55 823 6491

Royal Rubber Electric Equipment Trading LLC

1st street (behind nine Ball Building)
Al Qusais Industrial Area 3, Al Qusais
Dubai, UAE

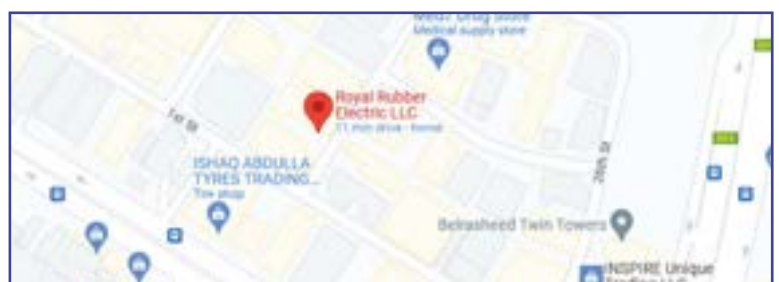

Location on Google Maps